



LED integrated monoblock pilot lights steady light LPML

Product designation

Product type designation

General characteristics

Colour	Red
Material	Polyamide
IEC degree of protection	IP66, IP67 and IP69K on front; IP20 on rear

Electrical characteristics

Rated frequency	Hz	50-60
Supply voltage (AC)	V	48 (-15% ... +10% Ue)
Supply voltage (DC)	V	48 (-15% ... +10% Ue)

Operations

Electrical life	hours	>30000
-----------------	-------	--------

Mechanical features

Tightening torque for terminals max	Nm	0.8
Terminals screw	Screw termination	

Conductor section

AWG/kcmil conductor section

min	18
max	16

IEC

max	mm ²	2.5
-----	-----------------	-----

Fixing	Ring fixing Ø22mm
--------	-------------------

Weight	g	21
--------	---	----

UL technical data

UL degree of protection	Type1, 2, 3R, 4, 4X, 12, 12K on front
-------------------------	---------------------------------------

Ambient conditions

Temperature

Operating temperature

min	°C	-25
max	°C	+70

Dimensions

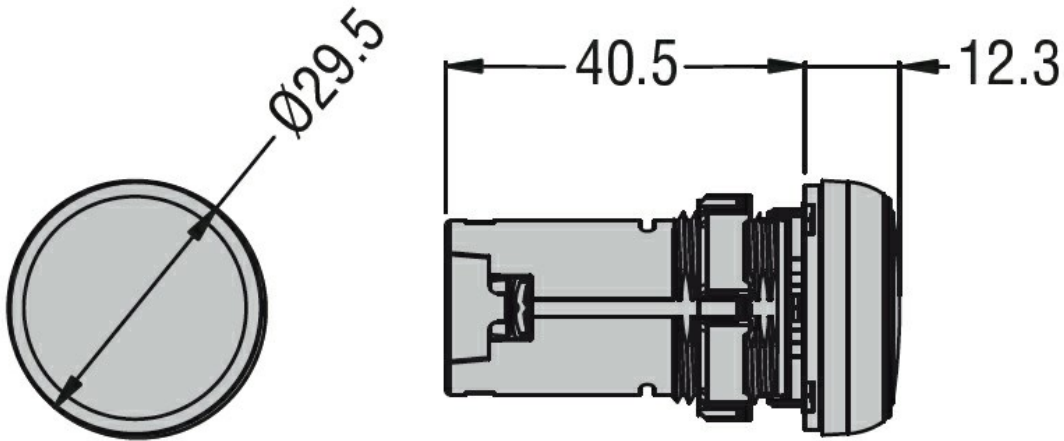

Wiring diagrams

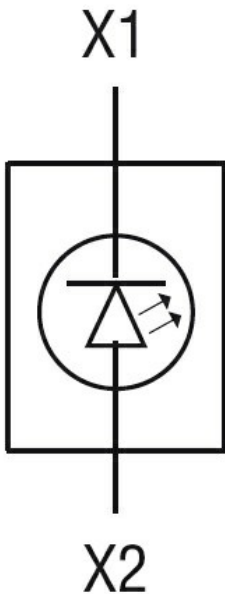

Certifications and compliance

Compliance

CSA C22.2 n° 14
IEC/EN/BS 60947-1
IEC/EN/BS 60947-5-1
UL508

Certificates

cULus
EAC

ETIM classification

ETIM 8.0

EC000272 -
Indicator light
complete